

Attenuator

The Best Wireless Solution!

SMA 2Watt 20dB 12.4GHz Attenuator

P.N. : F01-B1320-02

Products feature

- Reliable Attenuation & V.S.W.R
- Easy maintenance
- Wide broadband frequency application
- Bi-Directional 2 Watt rating

Electrical specification

Item	Specification
Frequency range	DC ~ 12.4 GHz
Impedance (Nominal)	50Ω
Average Power rating	2 Watt
Peak Power(5 μs)	0.5 KW
Attenuation	20 dB +/- 0.7 dB/max
V.S.W.R (Max)	1.30 : 1
Connector type	SMA male – female

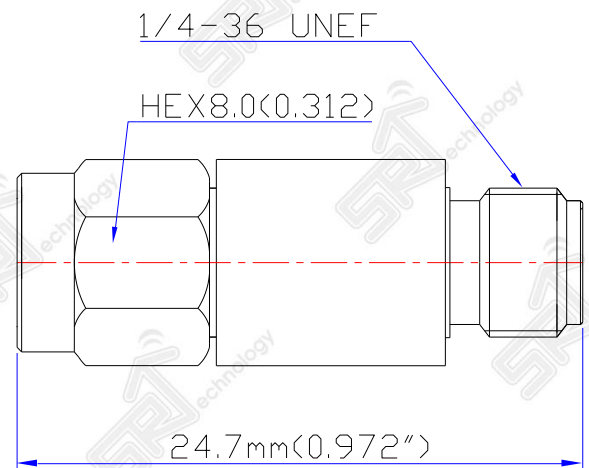

Electrical performance

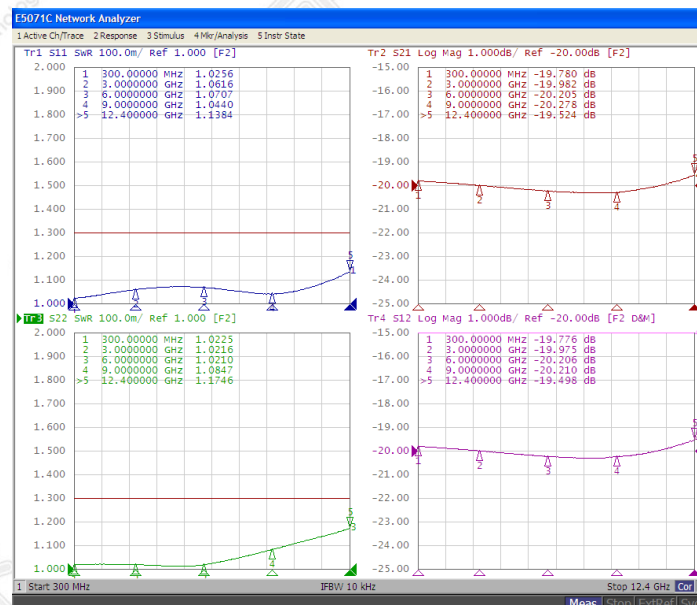

Material specification

Item	Specification
Center Contact (pin)	Brass, Beryllium copper / Gold plating
Body	SUS / Passivated.
Insulator	PTFE
Temperature Range	-55°C ~ +85°C
Weight	10 g